

BEDLOCKER®

ELECTRIC RETRACTABLE TRUCK BED COVER

2007 TOYOTA TUNDRA INSTALLATION INSTRUCTIONS



(Picture shown may be different than actual application)



#1 RETRACTABLE TRUCK BED COVER

(800) 338-3697

www.paceedwards.com

Pace Edwards Company
2400 Commercial Blvd.
Centralia WA 98531

TABLE OF CONTENTS

Tools Required for Assembly	2
Before You Start	2
Drain Hole Locations	2
STEP 1: Remove Contents from Box	2
Packaging Contents	3
STEP 2: Install Wiring Harness	3
STEP 3: Place Canister.....	3
STEP 4: Install Rails.....	4
STEP 5: Installing Clamps & Shims	4
STEP 6: Final Canister Positioning	5
STEP 7: Installing Drain Tubes.....	5
STEP 8: Install Top Cover	6
Helpful Maintenance Hints	6
Warranty Statement.....	7

TOOLS REQUIRED FOR ASSEMBLY:

7/16" wrench or socket #2 Phillips screwdriver #30 Torx Bit
Side Cut Pliers Tape measure

Note: There should be no drilling into the truck body needed on most standard or full-size trucks .

BEFORE YOU START:

Read the instructions carefully before you start. These instructions are written for one-person installation. We have noted where briefly having an extra person's assistance can make installation easier. If you have questions regarding the installation please call our Technical Support Line at (800) 338-3697.

DRAIN HOLE LOCATIONS:

The BedLocker is designed to carry rainwater from the cover into the canister and then out through the drains. Most truck models have standard OE drain holes or plastic/rubber access ports in the front of the truck bed. Check to make sure your truck has the OE drain holes so that drilling into the sheet metal is not required. If drilling is necessary, be sure to check the underside of the truck bed for the best location. The holes should be located near the side and as far forward as possible. Use a drill bit suitable for sheet metal (such as a taper drill or step drill). Drill drain tube clearance holes at 3/4" (19mm). This will need to be done before installing the cover.

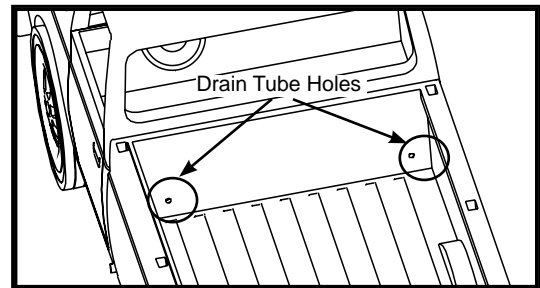

OPTIONAL WIRING HARNESS FOR DASHBOARD SWITCH:

The BedLocker also offers an optional wire harness (**part # BL1120**) to manually operate the tonneau cover from inside the cab of your truck.

This harness is designed to plug into the custom-built electronics control box mounted inside the canister.

Thread the plug through the side of the canister and connect it to the grey/violet plug. Make sure to secure the loose wires inside the canister away from the gear and blanket.

Then run the wire to the cab and attach under the dash in a suitable location.

STEP 1: REMOVE CONTENTS & PLYWOOD PACKAGING

HARDWARE USED:

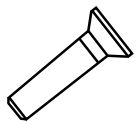

RAIL GUIDE BOLT x 4

Remove the canister and top cover from the box.

Remove components from inside the canister. Perform a quick inventory to insure all parts are there.

Using the wrench or socket remove the 2 bolts holding the plywood packaging supports on the ends of the canister. Discard plywood packaging supports and bolts.

Locate the rail guide bolts in the hardware pack and install them in the two holes where the packaging bolts and plywood were just removed. Repeat on both ends of the canister.

PACKAGING CONTENTS:

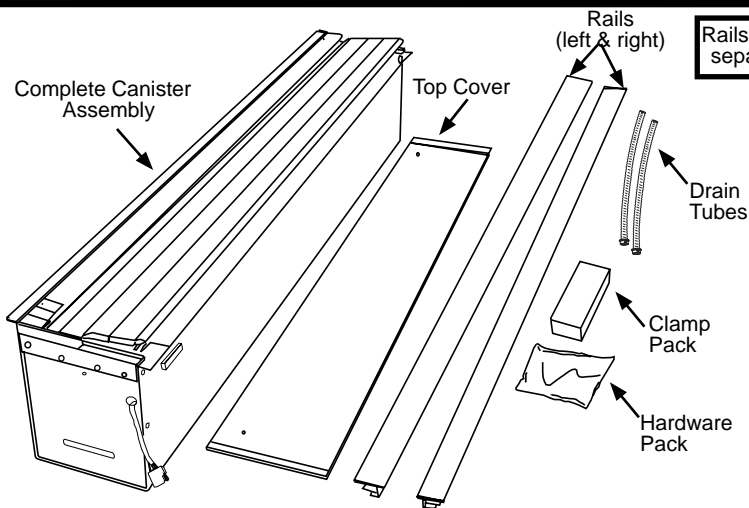

DO NOT USE A KNIFE TO OPEN THE RAIL BOX.

OPEN THE RAIL BOX ALONG THE LENGTH OF THE BOX AND LIFT RAILS OUT TO AVOID SCRATCHING THE SURFACE OF THE RAILS ON THE PACKAGE STAPLES.

STEP 2: INSTALL WIRING HARNESS

HARDWARE USED:

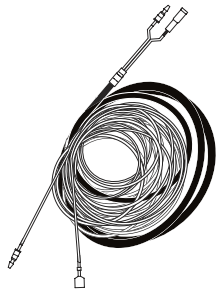

WIRE HARNESS x 1



ZIP TIES x 5

(If the optional wire harness **Part# BL1120** is used, you may want to tape it to the main harness to ease having to pull them through the stake pocket separately).

From inside the truck bed push the long wire harness end **without** the plug through the stake pocket on the drivers side of the truck and out the underside of the truck bed box.

Leave approximately one foot of slack inside the box for mounting the electronics.

Route the wire harness under the truck and to the battery in the engine compartment.

Attach the fuse holder to the end of the Red/positive wire.

(Do not attach to the battery yet.)

Secure the harness with wire ties provided after slack from the canister has been taken out.

STEP 3: PLACE CANISTER IN TRUCK BED

Use the #30 Torx Bit to remove the Front Track (against the cab) of the Deck Rail System from the truck bed if it is installed on the truck.

You will need one or two support pieces (We suggest using the top of the box the Bedlocker was shipped in) to set in the truck bed.

Set the support piece approximately one foot from the cab.

Set the Canister on the support(s) in the truck bed. The canister should be resting on the support piece, centered in the truck bed, raising the top of the canister above the bed rails by 2-3 inches.

Hold onto the ribbed blanket and cut the zip tie.

(Do not let the blanket roll back on itself or the underside on the first three ribs can damage the visual surface of the other rolled ribs).

Remove all of the vinyl sheeting protecting the blanket.

Pull the blanket out about 1 foot from the canister and let it hang.

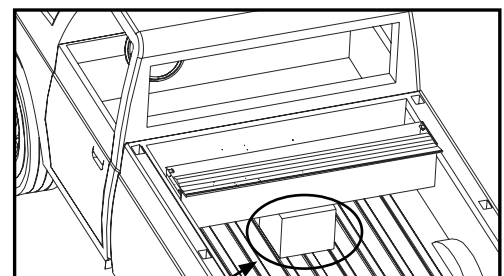

Support Piece

STEP 4: INSTALLING RAILS

The machined end of the rail attaches to the canister.

You will need to lift the hanging portion of the ribbed blanket and thread it in the rail while sliding the rail into the rail grip mounted to the ends of the canister (***the underside of the blanket ribs need to nest on the gear***).

Make sure both flanges of rail slide into the rail grip.

Push the rails forward against the canister.

Complete for both left and right rails.

Remove the support or stand and lower the canister and rail assembly onto the front sill and rails of the truck bed.

Slide the entire canister and rail assembly forward against the cab end of the truck bed.

Close the tailgate and pull the rails only toward it leaving approximately 1/8" gap between the end of the rails and the tailgate.

Be sure to hold the canister in place to ensure it does not move from the front truck bed sill with the rails while adjusting the gap of the rails to the tailgate.

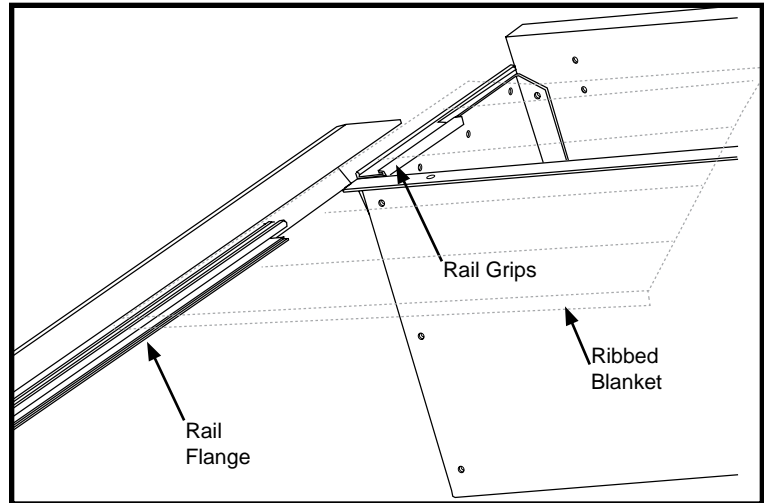

STEP 5: INSTALLING CLAMPS & SHIMS

HARDWARE USED:

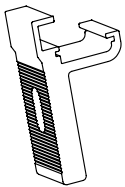

CLAMP x 4



TRACK NUTS x 4 (used if truck bed has track system)

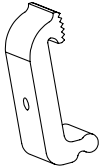

PINCH CLAMP x 4 (used if truck bed DOES NOT have the deck rail track system)



1/4" FLAT WASHER x 4



1/4" LOCK WASHER x 4



RAIL CLAMP BOLT x 4

The Tundra bed is square and the clamps have been designed to fit without shimming.

Make sure canister is centered between the truck bed rails and completely forward in the bed.

Slide rail grip components onto rail.

Push forward clamp against the canister and rear clamp about 6 inches to a foot from the tailgate.

Slide track nuts into the track system and use attachment hardware (Flat washer, Lock washer & Bolt) to secure clamps in place per FIG 5a.

Measure the distance between the rails at the canister and tailgate ends. Compare this distance after clamping it should be the same to allow your cover to operate properly. A slightly tighter fit (but NOT Dragging) is better than slightly loose.

If the bed does not have the deck rail track system you will use the pinch clamp in place of the track nut. (Fig 5b)

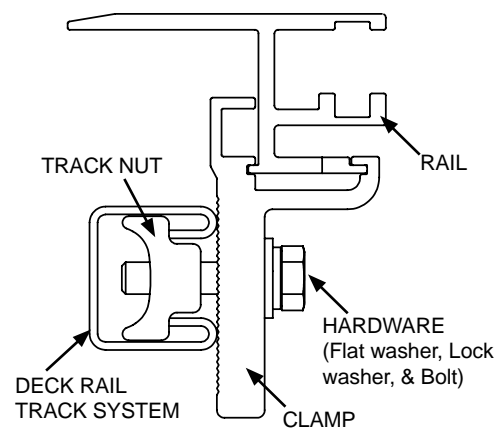

FIG. 5a

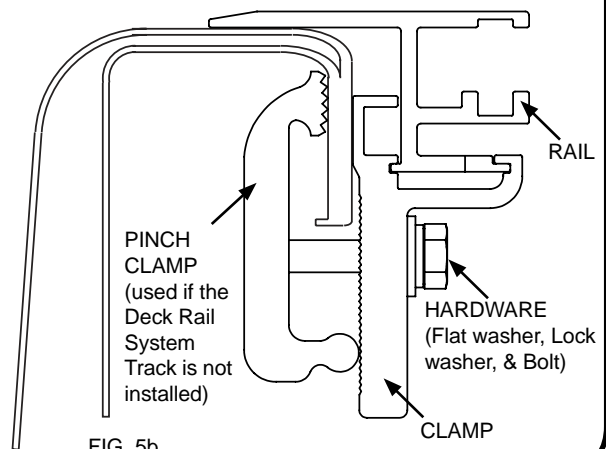

FIG. 5b

STEP 6: FINAL CANISTER POSITIONING

HARDWARE USED:



2-BUTTON REMOTE
KEY FOB x 2

The electronics box has been pre-mounted to the inside of the canister.

Connect the battery wire harness into the 2-wire plug at the end of the canister (**also connect the optional manual switch harness, if installed at this time**)

Attach the Red (positive) and Black (negative) wires to the battery or the truck manufacturers suggested connection points at this time.

Unit is now ready to operate.

Press the Open button to open cover and press the Close button to shut the cover.

This diagram is provided for reference only.

WIRING DIAGRAM

A. Canister Harness

Blue...Close

Green...Open

Black...Brake – hot or ground

Black...Brake – hot or ground

B. Optional Manual Switch Harness

Gray...Open

Violet...Closed

C. Battery Harness

Red...Power

Black...Ground

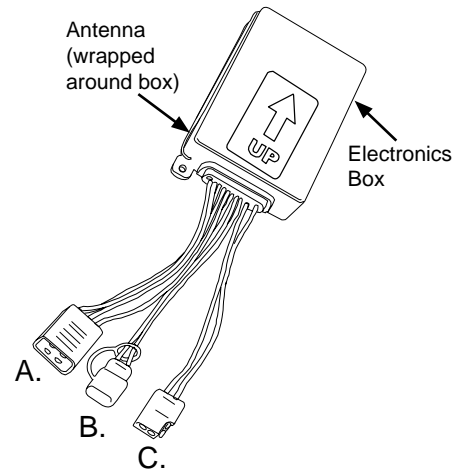

STEP 7: INSTALLING DRAIN TUBES

First ensure that the “o” ring is in place on the drain tube end being inserted into the canister (This will prevent water leakage).

With the cover *opened*, insert the drain tube fittings into the pre-drilled holes on the underside of the canister by pushing them in place from under the canister. Drain tube should click into place.

Place the other end of the drain tube through the grommet or through the pre-drilled holes in the floor or the front wall of the truck bed.

DRAIN TUBE FITTING

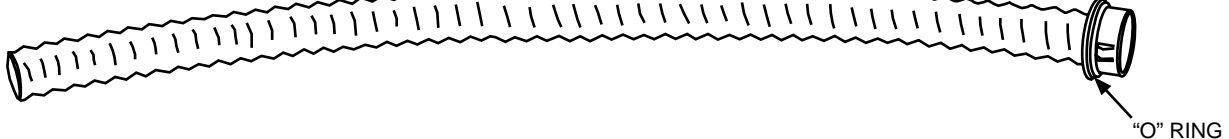

STEP 8: ATTACHING TOP COVER & VELCRO TO PULL STRAP

HARDWARE USED:



CLOSE CELL FOAM x 1



BLACK TOP COVER SCREW x 2

Peel the foam backing and attach the foam to the front sill of the truck bed as shown in FIG. 8.

Place the top cover on the canister opening and install the (2) Black Top Cover Screws into the attachment blocks mounted to the inside of the canister.

Hold the top cover tight against the cab side of the box while tightening.

(The top cover can be adjusted slightly to align evenly with the ribbed blanket)

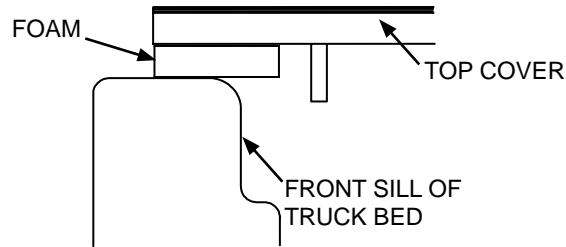

You have now completed the installation of the Bedlocker Electric hard tonneau cover. If you have any questions please do not hesitate to call us at: (800) 338-3697 and ask for our technical service department.

HELPFUL MAINTENANCE HINTS

After installation, if the cover is tight or hard to open and close, the shimming may need to be re-adjusted.

Periodically remove the Top Cover and clean out the canister.

Drain tubes may become clogged overtime and should be removed and cleaned. To remove the drain tubes you must; Remove the Top Cover, close the cover to the tailgate, reach in the canister and depress the plastic retaining tabs on the drain tube fittings and push the drain tube out of the hole in the bottom of the canister. (Fig. 1)

To help keep the Bedlocker retractable tonneau cover looking its best, we recommend washing it the same as caring for your truck finish. However due to the hammer texture, removal of wax can be difficult so you should not wax your cover.

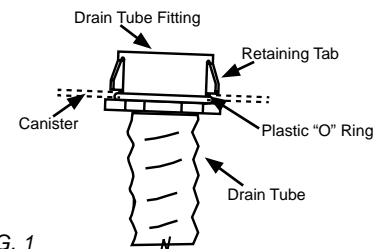

CONGRATULATIONS!

Cover. We are confident that you will get many years of trouble free service from this accessory to your truck. Please take a moment to fill out the warranty registration form to activate warranty coverage of your truck bed cover.

PACE EDWARDS PRODUCT WARRANTY

PACE EDWARDS (hereinafter referred to as the MFG.) warrants each new Pace Edwards Bedlocker®, JackRabbit®, Full-Metal-JackRabbit™, and Roll-Top-Cover® retractable truck bed cover to the original owner as follows:

FOR A PERIOD OF THREE (3) YEARS FROM THE DATE THE UNIT IS DELIVERED TO THE FIRST PURCHASER OR PLACED INTO SERVICE AS A DEMONSTRATOR OR COMPANY UNIT:

- Delamination of the ArmorTek deck
- Separation of the Bedlocker/Full Metal deck panels
- Failure of the Continuous Tension Spring
- Failure of the Bedlocker drive system
- All lock assemblies
- All hardware and components

ITEMS NOT COVERED UNDER WARRANTY FOR ANY PERIOD OF TIME:

- Rips, tears, or discoloration of the ArmorTek deck material
- Seals and gaskets
- Water intrusion from any source
- Dealer and/or purchaser installed parts and accessories

CERTAIN CONDITIONS WILL VOID ALL WARRANTY.

These conditions include:

- Use for any purpose other than normal private use including rental and promotion
- Altering the retractable truck bed cover in any manner without written approval of the MFG
- Misuse, negligence or accident
- Installation of any part or accessory without written approval from the MFG
- Failure to register this warranty with the MFG within fourteen (14) days from date of delivery

CLAIM PROCEDURE

If a part fails, the purchaser should return to the selling dealer to determine if the failed part is covered under the terms of this warranty. If a Warranty Claim is necessary, the dealer will contact Pace Edwards to obtain A Return Goods Authorization. If it is impractical for the purchaser to return to the selling dealer, then the purchaser may contact the Pace Edwards Technical Assistance Help Desk at 1-800-338-3697 to determine warranty eligibility. In either event, it is the responsibility of the purchaser to obtain a Return Goods Authorization prior to returning the defective part to the MFG. The defective part, along with a copy of the original Bill of Sale and the Pace Edwards issued RGA #, must be returned PREPAID to Pace Edwards Co. 2400 Commercial Blvd. Centralia, WA 98531. After determining the validity of the warranty claim, PACE EDWARDS will ship a replacement part prepaid to the customer. Labor costs to replace defective parts are the responsibility of the purchaser.

CONDITIONS AND LIMITATIONS

This warranty is subject to certain conditions and limitations including, but not limited to, the following:

- Any part of a Pace Edwards retractable truck bed cover that is found to be defective under the terms of this warranty will be repaired or replaced using either new or reconditioned parts at the discretion of the MFG.
- In determining what constitutes a failure under the terms of this warranty the decision of the MFG shall be final.
- This warranty is extended to the original purchaser only and is not transferable to subsequent purchasers.
- The MFG does not accept any responsibility in connection with the installation of any of its products by its dealers or agents.
- The MFG does not undertake responsibility to any purchaser for warranty express or implied by any of its dealers, distributors or agents beyond that which is contained herein.
- Without regard to an alleged defect of its products the MFG under any circumstances does not assume responsibility for loss of time, inconvenience, revenue, or other consequential damage including, but not limited to, expenses for telephone, food, lodging, travel, loss or damage to the vehicle the products are installed on or loss or damage to personal property of the purchaser or user of the products.
- The MFG reserves the right to make changes in the design of, improvements to, or warranty of its products without imposing any obligation upon itself to provide the same for any products theretofore manufactured.

Some jurisdictions do not allow limitations on or exclusions to warranties, therefore some of the exclusions may not apply to you. This warranty affords you specific legal rights. You may have other legal rights that may vary from jurisdiction to jurisdiction.

WARRANTY REGISTRATION

Please return this completed warranty registration within 14-days to:
Or go online and register your warranty at: www.paceedwards.com/reg.asp

Pace Edwards
Attn: Warranty Dept.
2400 Commercial Blvd.
Centralia, WA 98531



NAME: _____

ADDRESS: _____

CITY: _____ PROV./STATE: _____ PC/ZIP: _____

MODEL #: _____ SERIAL #: _____

DATE OF PURCHASE: _____ PURCHASED FROM: _____ PRICE PAID: _____

CUSTOMER SIGNATURE: _____

2400 Commercial Blvd, Centralia, WA 98531 USA
(360) 736-9991 (main) ♦ (360) 736-9992 (fax)
(800) 338-3697 (toll-free)
www.paceedwards.com

Thank you for choosing products by...

